

INSTRUCTIONS

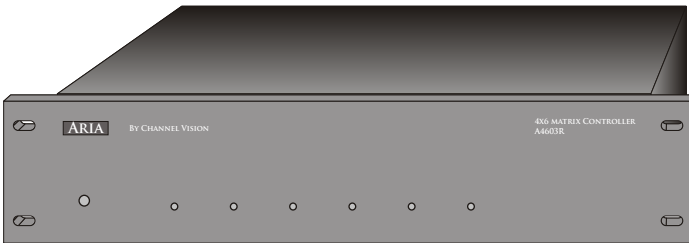
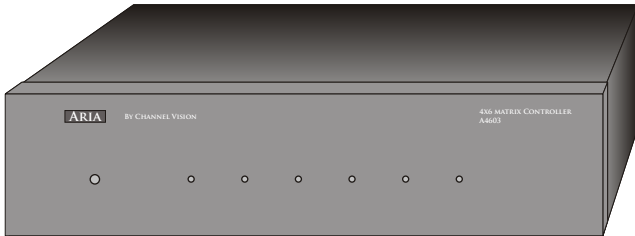

A4603

A4603R

4-input 6-zone Matrix AV Controller

ARIA
BY CHANNEL VISION™

©2007 CHANNEL VISION TECHNOLOGY

The **A4603/A4603R** is a 4 input 6 zone matrix A/V controller with pre-amp outputs for each of the 6 zones making it easy to integrate with a high power multichannel amplifier such as Channel Vision's A1260. Any of the 4 source inputs can be selected and routed to any of the 6 outputs (or zones) independent of the other zones.

Features:

- Pre-amp outputs are a perfect match for the A1260 multichannel amplifier
- Distributes 4 A/V sources to 6 different zones
- IR and Serial Control options
- Cost effective and easy to install

Dimensions do not include the rubber feet on the bottom of the unit or connectors which protrude from the rear of the unit. Rubber feet will add 0.5" to the height and connectors (without wires attached) will add 0.5" to the depth.



Accessories
(Sold Separately)

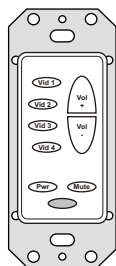

A0127 ... IR repeating keypad. The A0127 already contains the IR codes necessary to operate the A4603, but you may also use a standard IR receiver or a 3rd party keypad. When using a simple IR receiver, you will need to use the A0501 remote control which contains the IR codes to control the A4603. These codes can be downloaded from www.channelvision.com, or learned from an A0501 remote control.



A0501 or A0502 ... Remote control. Contains IR codes for controlling the A4603 as well as many other Channel Vision audio products. (A0501 shown).

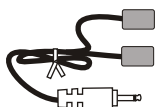

IR-3001 & IR-3002 ... Single and dual head IR flashers. Use one head per source to control from the remote room. (IR-3002 shown).

IMPORTANT SAFETY INSTRUCTIONS

1. Read these instructions.
2. Keep these instructions for future reference
3. Heed all warnings.
4. Follow all instructions.
5. Do not use this device near water.
6. Clean only with a dry cloth.
- 7 Do not block any ventilation openings. Install in accordance with these instructions.
8. Do not install near any heat sources such as radiators, heat registers, stoves, or other apparatus (including amplifiers) that produce heat. When installing multiple amplifiers in the same rack, provide space for air circulation above and below each unit.
9. Do not defeat the safety purpose of the polarized or grounding-type plug. A polarized plug, has two blades with one wider than the other. A grounding type plug has two blades and a third grounding prong. the wide blade or the third prong are provided fro your safety. If the provided plug does not fit into your outlet, consult an electrician for replacement of the obsolete outlet.
10. Protect the power cord from being walked on or pinched particularly at plugs, convenience receptacles, and the point where they exit from the apparatus.
11. Only use attachments/accessories specified by Channel Vision.
12. Use only with the cart, stand, tripod, bracket, or table specified by the manufacturer, or sold with the apparatus. When a cart is used, use caution when moving the cart/apparatus combination to avoid injury from tip-over.
13. Unplug this apparatus during lightning storms or when unused for long periods of time.
14. Refer all servicing to qualified service personnel. Servicing is required when the apparatus has been damaged in any way, such as power supply cord or plug is damaged, liquid has been spilled or objects have fallen into the apparatus, the apparatus has been exposed to rain or moisture, does not operate normally, or has been dropped.

15. 

CAUTION
RISK OF ELECTRIC SHOCK
DO NOT OPEN



Warning: To reduce the risk of electric shock, do not remove the cover (or back), no user serviceable parts inside, refer servicing to qualified service personnel.

Note: at frequencies between 150kHz to 1GHz, any deterioration of the sound and picture is so minor that the system could still be used and will function normally.

Wiring the A0127 keypad...

Keypads connect to the A4603 through the RJ-45 jacks on the back panel of the A4603. Connections to the A0127 may be accomplished either by using the RJ-45 jack or the screw terminals provided on the back side of the keypad. When using the RJ-45 jacks, simply wire both ends of the cable according to the TIA568A standard. When using the screw terminals on the A0127, make sure to wire the RJ-45 plug connecting to the A4603 as shown below.

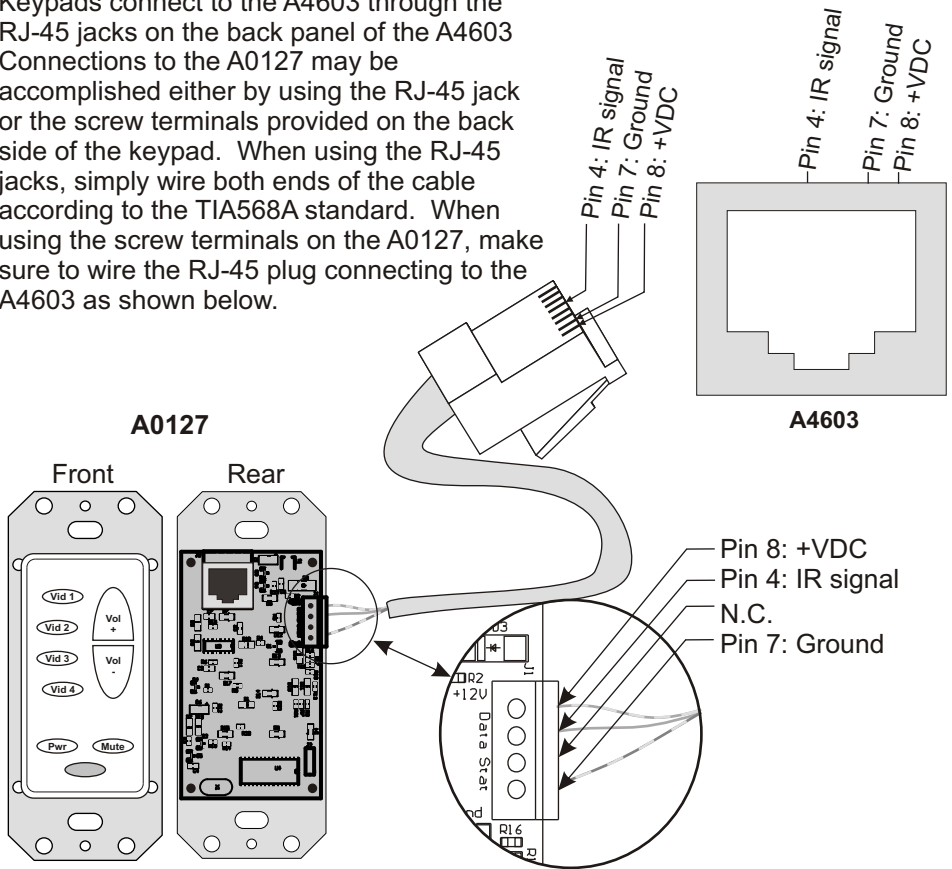

Connecting a standard IR repeater to the A4603... A standard IR repeating device may be connected directly to the A4603 allowing the unit to be controlled from a learning IR remote. The connection is similar to the wiring configuration shown above for the A0127, except there are only three wires as shown below.

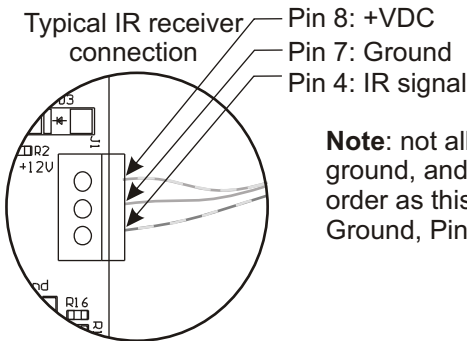

Note: not all IR receivers have the voltage, ground, and signal connections in the same order as this diagram. Pin 8: +VDC, Pin 7: Ground, Pin 4: IR.

Using the A0501 remote control...

The A0501 is designed to allow you to control your A4603 without having to touch the buttons on the A0127. Simply point the A0501 remote control at the IR sensor located at the bottom of the A0127 and press the desired button.

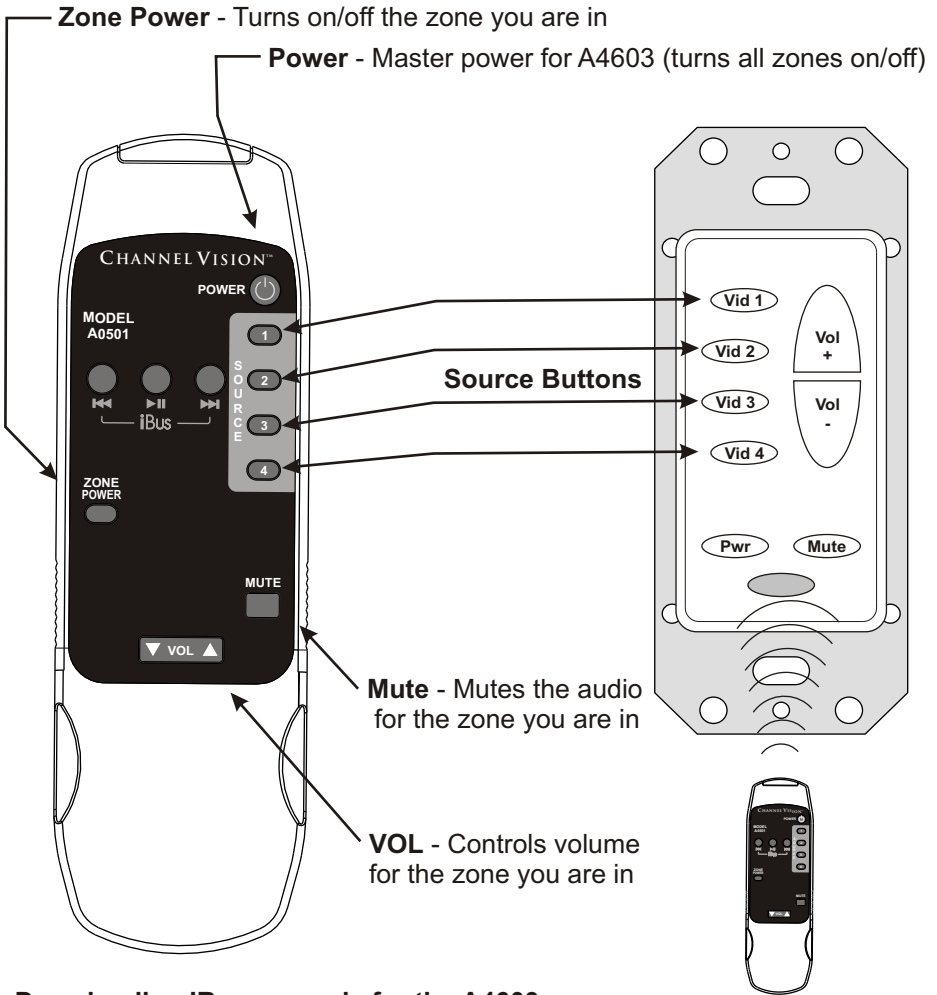

Downloading IR commands for the A4603...

If you don't have access to the A0501 remote and you need to program a learning remote, you can download the IR codes from the internet. IR codes compatible with the Philips Pronto remote controls can be downloaded from the following websites:

www.channelvision.com (Hex codes are also available)
www.remotecentral.com

A4603 Re

Each zone is controlled through the A0127 keypad which connects to the RJ45 jacks on the rear panel.
See page 4 for connection details

Connect serial data controller to the Serial port
(Hex codes on pages 8-11)

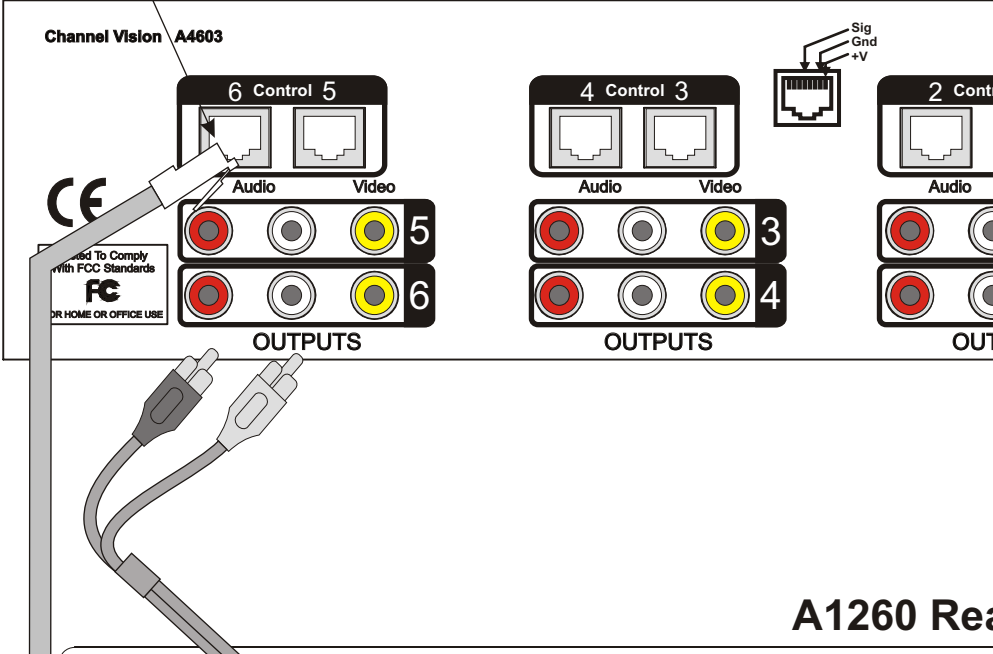

A1260 Rea

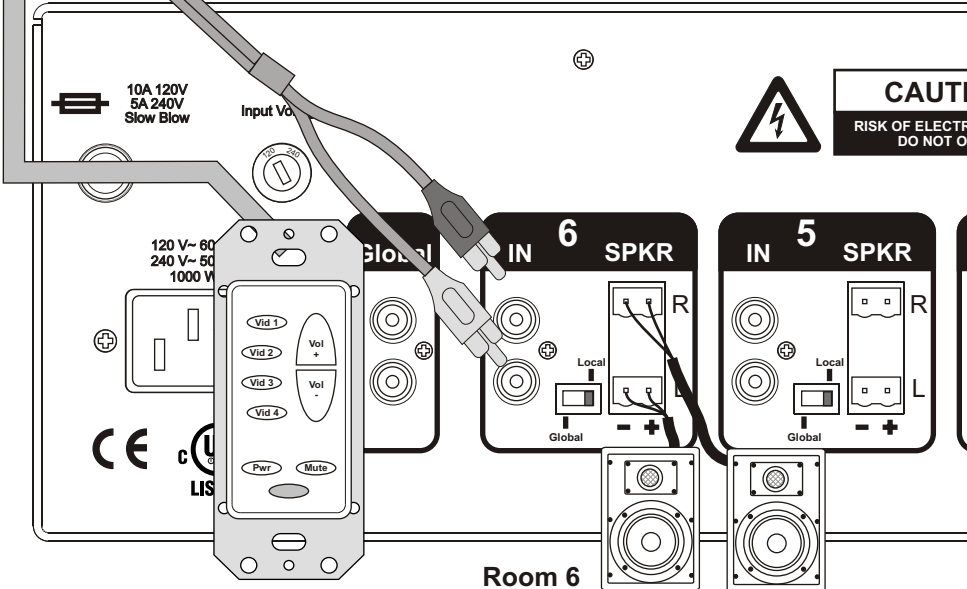

ear Panel

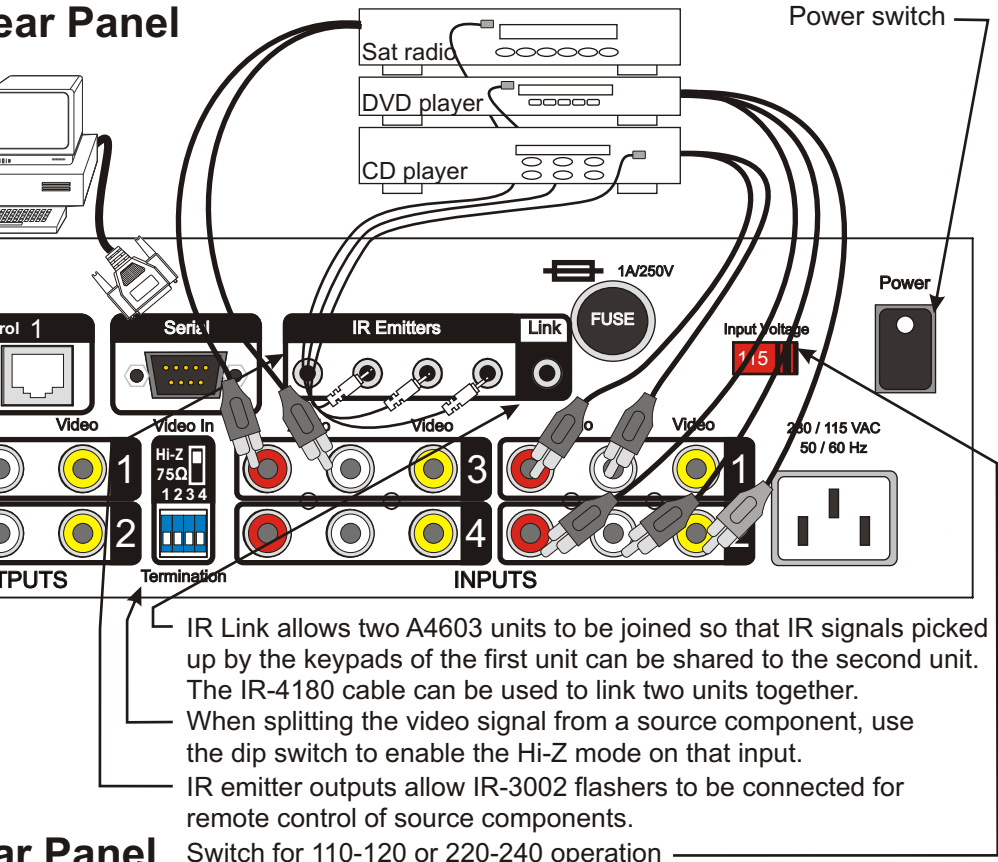

IR Link allows two A4603 units to be joined so that IR signals picked up by the keypads of the first unit can be shared to the second unit. The IR-4180 cable can be used to link two units together.

When splitting the video signal from a source component, use the dip switch to enable the Hi-Z mode on that input.

IR emitter outputs allow IR-3002 flashers to be connected for remote control of source components.

Switch for 110-120 or 220-240 operation

ear Panel

ION
ELECTRIC SHOCK
DANGER
OPEN



ARIA by CHANNEL VISION Model A1260 12 Channel Amplifier

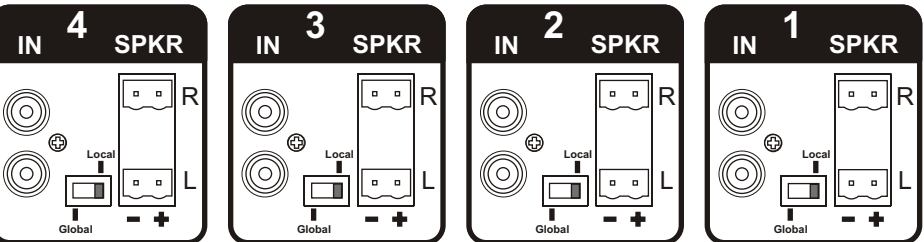

USE CLASS 2 WIRING FOR SPEAKER OUTPUTS

Made in China

RS-232 Control Code:

For installations requiring more sophistication the A4603 supports RS-232 making it well suited for use with automation systems.

Baud Rate: 19200, 8N1 (8Bit Data, No Parity, 1 Stop Bit)

Each transmission = 8 ASCII bytes

Check Sum = The sum of the first 7 bytes inverted and truncated

Note: the check sum for each command is included in the following charts.

There are two possible responses generated when a command is received:
ack - This acknowledges that the command was received and it had a valid check sum.

ZZZ - This means that the command was not understood or could not be decoded correctly. It could also mean that the check sum was not valid.

Serial Cable Pin Out

A4603 RS-232 Pins
DB-9P, Female

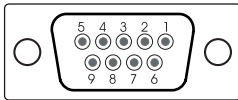

NC 1 ○
(TX) 2 ●
(RX) 3 ●
NC 4 ○
(GND) 5 ●
NC 6 ○
NC 7 ○
NC 8 ○
NC 9 ○

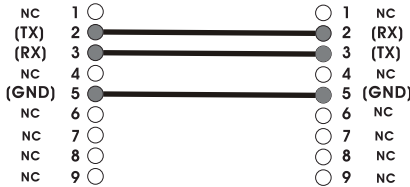

PC RS-232 Pins
DB-9P, Male

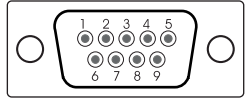

Zone 1 Commands

Function	ASCII Command	Hex Command
Zone 1 Power Toggle	A46Z1PL-	41 34 36 5A 31 50 4C 2D
All Power Toggle	A46Z1PA8	41 34 36 5A 31 50 41 38
Zone 1, Select Source 1	A46Z1S1E	41 34 36 5A 31 53 31 45
Zone 1, Select Source 2	A46Z1S2D	41 34 36 5A 31 53 32 44
Zone 1, Select Source 3	A46Z1S3C	41 34 36 5A 31 53 33 43
Zone 1, Select Source 4	A46Z1S4B	41 34 36 5A 31 53 34 42.
Zone 1, Volume Up	A46Z1V+H	41 34 36 5A 31 56 2B 48
Zone 1, Volume Down	A46Z1V-F	41 34 36 5A 31 56 2D 46
Zone 1, Volume Reset	A46Z1VC0	41 34 36 5A 31 56 43 30
Zone 1, Mute	A46Z1MT+	41 34 36 5A 31 4D 54 28
Zone 1, Request Status	A46Z1SF0	41 34 36 5A 31 53 46 30
Zone 1, Status Clear	A46Z1SC3	41 34 36 5A 31 53 43 33

Zone 2 Commands

Function	ASCII Command	Hex Command
Zone 2 Power Toggle	A46Z2PL'	41 34 36 5A 32 50 4C 2C
All Power Toggle	A46Z2PA7	41 34 36 5A 32 50 41 37
Zone 2, Select Source 1	A46Z2S1D	41 34 36 5A 32 53 31 44
Zone 2, Select Source 2	A46Z2S2C	41 34 36 5A 32 53 32 43
Zone 2, Select Source 3	A46Z2S3B	41 34 36 5A 32 53 33 42
Zone 2, Select Source 4	A46Z2S4A	41 34 36 5A 32 53 34 41
Zone 2, Volume Up	A46Z2V+G	41 34 36 5A 32 56 2B 47
Zone 2, Volume Down	A46Z2V-E	41 34 36 5A 32 56 2D 45
Zone 2, Volume Reset	A46Z2VC/	41 34 36 5A 32 56 43 2F
Zone 2, Mute	A46Z2MT'	41 34 36 5A 32 4D 54 27
Zone 2, Request Status	A46Z2SF/	41 34 36 5A 32 53 46 2F
Zone 2, Status Clear	A46Z2SC2	41 34 36 5A 32 53 43 32

Zone 3 Commands

Function	ASCII Command	Hex Command
Zone 3 Power Toggle	A46Z3PL+	41 34 36 5A 33 50 4C 2B
All Power Toggle	A46Z3PA6	41 34 36 5A 33 50 41 36
Zone 3, Select Source 1	A46Z3S1C	41 34 36 5A 33 53 31 43
Zone 3, Select Source 2	A46Z3S2B	41 34 36 5A 33 53 32 42
Zone 3, Select Source 3	A46Z3S3A	41 34 36 5A 33 53 33 41
Zone 3, Select Source 4	A46Z3S4@	41 34 36 5A 33 53 34 40
Zone 3, Volume Up	A46Z3V+F	41 34 36 5A 33 56 2B 46
Zone 3, Volume Down	A46Z3V-D	41 34 36 5A 33 56 2D 44
Zone 3, Volume Reset	A46Z3VC.	41 34 36 5A 33 56 43 2E
Zone 3, Mute	A46Z3MT&	41 34 36 5A 33 4D 54 26
Zone 3, Request Status	A46Z3SF.	41 34 36 5A 33 53 46 2E
Zone 3, Status Clear	A46Z3SC1	41 34 36 5A 33 53 43 31

Zone 4 Commands

Function	ASCII Command	Hex Command
Zone 4 Power Toggle	A46Z4PL*	41 34 36 5A 34 50 4C 2A
All Power Toggle	A46Z4PA5	41 34 36 5A 34 50 41 35
Zone 4, Select Source 1	A46Z4S1B	41 34 36 5A 34 53 31 42
Zone 4, Select Source 2	A46Z4S2A	41 34 36 5A 34 53 32 41
Zone 4, Select Source 3	A46Z4S3@	41 34 36 5A 34 53 33 40
Zone 4, Select Source 4	A46Z4S4?	41 34 36 5A 34 53 34 3F
Zone 4, Volume Up	A46Z4V+E	41 34 36 5A 34 56 2B 45
Zone 4, Volume Down	A46Z4V-C	41 34 36 5A 34 56 2D 43
Zone 4, Volume Reset	A46Z4VC-	41 34 36 5A 34 56 43 2D
Zone 4, Mute	A46Z4MT%	41 34 36 5A 34 4D 54 25
Zone 4, Request Status	A46Z4SF-	41 34 36 5A 34 53 46 2D
Zone 4, Status Clear	A46Z4SC0	41 34 36 5A 34 53 43 30

Zone 5 Commands

Function	ASCII Command	Hex Command
Zone 5 Power Toggle	A46Z5PL)	41 34 36 5A 35 50 4C 29
All Power Toggle	A46Z5PA4	41 34 36 5A 35 50 41 34
Zone 5, Select Source 1	A46Z5S1A	41 34 36 5A 35 53 31 41
Zone 5, Select Source 2	A46Z5S2@	41 34 36 5A 35 53 32 40
Zone 5, Select Source 3	A46Z5S3?	41 34 36 5A 35 53 33 3F
Zone 5, Select Source 4	A46Z5S4>	41 34 36 5A 35 53 34 3E
Zone 5, Volume Up	A46Z5V+D	41 34 36 5A 35 56 2B 44
Zone 5, Volume Down	A46Z5V-B	41 34 36 5A 35 56 2D 42
Zone 5, Volume Reset	A46Z5VC'	41 34 36 5A 35 56 43 2C
Zone 5, Mute	A46Z5MT\$	41 34 36 5A 35 4D 54 24
Zone 5, Request Status	A46Z5SF'	41 34 36 5A 35 53 46 2C
Zone 5, Status Clear	A46Z5SC/	41 34 36 5A 35 53 43 2F

Zone 6 Commands

Function	ASCII Command	Hex Command
Zone 6 Power Toggle	A46Z6PL(41 34 36 5A 36 50 4C 28
All Power Toggle	A46Z6PA3	41 34 36 5A 36 50 41 33
Zone 6, Select Source 1	A46Z6S1@	41 34 36 5A 36 53 31 40
Zone 6, Select Source 2	A46Z6S2?	41 34 36 5A 36 53 32 3F
Zone 6, Select Source 3	A46Z6S3>	41 34 36 5A 36 53 33 3E
Zone 6, Select Source 4	A46Z6S4=	41 34 36 5A 36 53 34 3D
Zone 6, Volume Up	A46Z6V+C	41 34 36 5A 36 56 2B 43
Zone 6, Volume Down	A46Z6V-A	41 34 36 5A 36 56 2D 41
Zone 6, Volume Reset	A46Z6VC+	41 34 36 5A 36 56 43 2B
Zone 6, Mute	A46Z6MT#	41 34 36 5A 36 4D 54 23
Zone 6, Request Status	A46Z6SF+	41 34 36 5A 36 53 46 2B
Zone 6, Status Clear	A46Z6SC.	41 34 36 5A 36 53 43 2E

Global Commands

Function	ASCII Command	Hex Command
Global, Zone Power Toggle	A46ZAPL[group sep]	41 34 36 5A 41 50 4C 1D
Global, Select Source 1	A46ZAS15	41 34 36 5A 41 53 31 35
Global, Select Source 2	A46ZAS24	41 34 36 5A 41 53 32 34
Global, Select Source 3	A46ZAS33	41 34 36 5A 41 53 33 33
Global, Select Source 4	A46ZAS42	41 34 36 5A 41 53 34 32
Global, Volume Up	A46ZAV+8	41 34 36 5A 41 56 2B 38
Global, Volume Down	A46ZAV-6	41 34 36 5A 41 56 2D 36
Global, Volume Reset	A46ZAVC[sp]	41 34 36 5A 41 56 43 20
Global, Mute	A46ZAMT[cancel]	41 34 36 5A 41 4D 54 18
Global, Request Status	A46ZASF[sp]	41 34 36 5A 41 53 46 20
Global, Status Clear	A46ZASC#	41 34 36 5A 41 53 43 23

Note: this chart contains some ASCII commands that include non-standard ASCII characters (characters which are not included on a standard keyboard). When programming a controller with these functions, it may be necessary to use the Hexadecimal equivalent shown in the far right hand column.



2 Year Limited Warranty

Channel Vision Technology will repair or replace any defect in material or workmanship which occurs during normal use of this product with new or rebuilt parts, free of charge in the USA, for two years from the date of original purchase. This is a no hassle warranty with no mail in warranty card needed. This warranty does not cover damages in shipment, failures caused by other products not supplied by Channel Vision Technology, or failures due to accident, misuse, abuse, or alteration of the equipment. This warranty is extended only to the original purchaser, and a purchase receipt, invoice, or other proof of original purchase date will be required before warranty repairs are provided.

Mail in service can be obtained during the warranty period by calling (800) 840-0288 toll free. A Return Authorization number must be obtained in advance and can be marked on the outside of the shipping carton.

This warranty gives you specific legal rights and you may have other rights (which vary from state to state). If a problem with this product develops during or after the warranty period, please contact Channel Vision Technology, your dealer or any factory-authorized service center.

Specifications: (typical @25° C)

Audio

Bandwidth:	20-20kHz
Crosstalk:	-90 dB
Dynamic Range:	6.0 Vp-p
THD:	0.01%

Video

Bandwidth:	DC-20MHz
Crosstalk:	-60 dB

Specifications subject to change without notice.



234 Fischer Avenue, Costa Mesa, California 92626 USA
(714)424-6500 • (800)840-0288 • (714)424-6510 fax
email: techsupport@channelvision.com